

Project:	
Type:	
Catalog #:	

**DESCRIPTION**

Compact Dusk-to-Dawn LED Area Light |  
 Power Select 60W/40W/30W all in one |  
 Color Select 5000K/4000K/3000K all in one |  
 120–277V Input | Gray Housing

**APPLICATION**

Arm-mount or structure-mount outdoor illumination needs (including barns, garages, parking areas, and other general purpose or security lighting requirements)



**PRODUCT FEATURES**

- Compact design matches appearance and light distribution of legacy HID, optimized for one for one replacements
- Heavy-duty, die-cast aluminum housing with ample heat sinking for enhanced thermal performance
- 3-pin twist-lock photocell included along with integrated NEMA/ANSI C136.10 3-pin twist-lock receptacle
- Power Select Technology allows fixture to be set to 60W, 40W, or 30W settings
- Color Select Technology features adjustable CCT: 5000K, 4000K, or 3000K
- Impact resistant and highly diffused poly carb lens with anti-yellowing agent, offers reduced glare for low mounting height applications
- Mounts directly to a structure OR a pole arm of 1 5/8”–2 3/8” diameter with universal clamp
- Powered by 0–10V dimming LED driver
- Ambient operating temperature: –40°C/–40°F to 50°C/122°F
- UL Certified for wet locations, IP65
- 0–10V dimming, 10% min
- Power factor: >0.95
- THD: <20%
- LED chip lifetime: L70 >100,000 hrs @ 25C°/77F° ambient fixture temp
- Meets FCC Part 15, Part B, Class A standards for conducted and radiated emissions

**ELECTRICAL SPECIFICATIONS**

Wattage	Lumens	Efficacy	Dimming	Color Temp	CRI	Dist Type	Input Voltage	Rated Life	Legacy Equivalent	Housing Color	Additional Feature
60W or 40W or 30W	9,250 lm or 6,850 lm or 5,200 lm	155–170 lm/W	0–10V	5000K 4000K 3000K	>80	V	120–277V	50,000 hrs	150–250W	Gray	3-pin twist-lock photocell included Structure-mount or arm-mount (2' curved-arm mounting pipe [sold separately])

Project:	
Type:	
Catalog #:	

**ALED60PS-D2D-WM-8CSB**  
**DUSK-TO-DAWN LED AREA LIGHT FIXTURES**

**MOUNTING OPTIONS**

Two different mounting accessories are included with this fixture. Use the proper accessory for the application you choose.

**Pole Arm Mount**

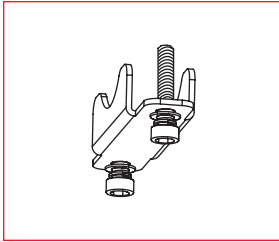

**Structure Mount**

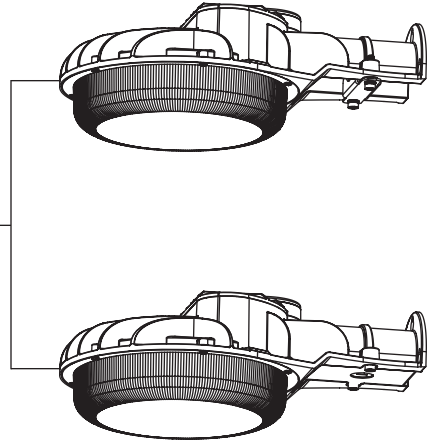
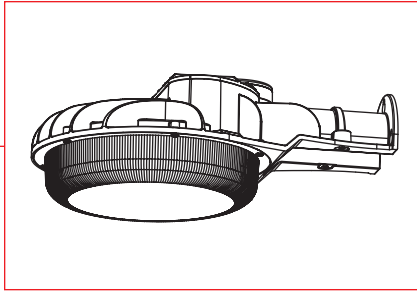
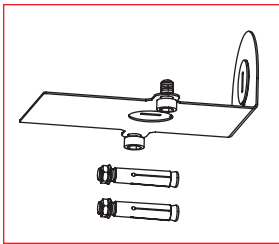

**24" CURVED POLE ARM KIT (SOLD SEPARATELY)**

Catalog Number	Description	UPC	Easy Code
ALED-CA-D2D-KIT	24" Curved Arm Mounting Pole, for Dusk-to-Dawn Area Light; Gray	843654131665	BFC-98



Project:	
Type:	
Catalog #:	

# ALED60PS-D2D-WM-8CSB DUSK-TO-DAWN LED AREA LIGHT FIXTURES

## PHOTOMETRIC SPECIFICATIONS

### ISOCANDELA PLOT

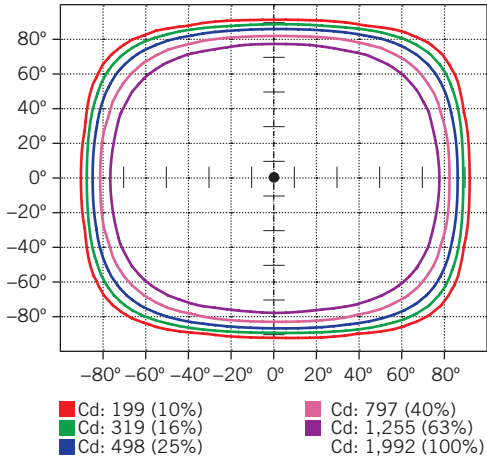

### LUMINOUS INTENSITY DISTRIBUTION

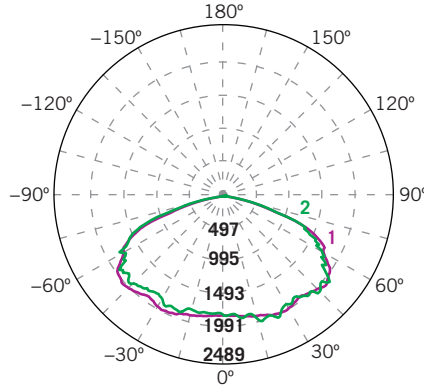

### FLUX DISTRIBUTION

Zone	Lumens	% Luminaire
<b>Forward Light</b>	4,121 lm	49.3%
0°-30°	783 lm	9.4%
30°-60°	2,166 lm	25.9%
60°-80°	1,111 lm	13.3%
80°-90°	60 lm	0.7%
<b>Back Light</b>	4,120 lm	49.2%
0°-30°	759 lm	9.1%
30°-60°	2,121 lm	25.4%
60°-80°	1,171 lm	14.0%
80°-90°	68 lm	0.8%
<b>Up Light</b>	126 lm	1.5%
90°-100°	43 lm	0.5%
100°-180°	83 lm	1.0%

BUG* Rating	
<b>Asymmetrical Luminaire Types</b>	
Type I, II, III, IV	B3 U3 G3
<b>Quadrilateral Symmetrical Luminaire Types</b>	
Type V, Area Light	B3 U3 G1

\* Backlight, Uplight, Glare

## LIGHT DISTRIBUTION PATTERN (TYPE 5 [V])

### DUSK-TO-DAWN

- Photometric layout for general reference only
- Grid dimension: 10 × 10 sq ft

- 0.1 fc
- 0.2 fc
- 0.5 fc
- 1.0 fc
- 2.0 fc
- 5.0 fc
- 10.0 fc

Arm-mount view from above; Area light mounted at 20'

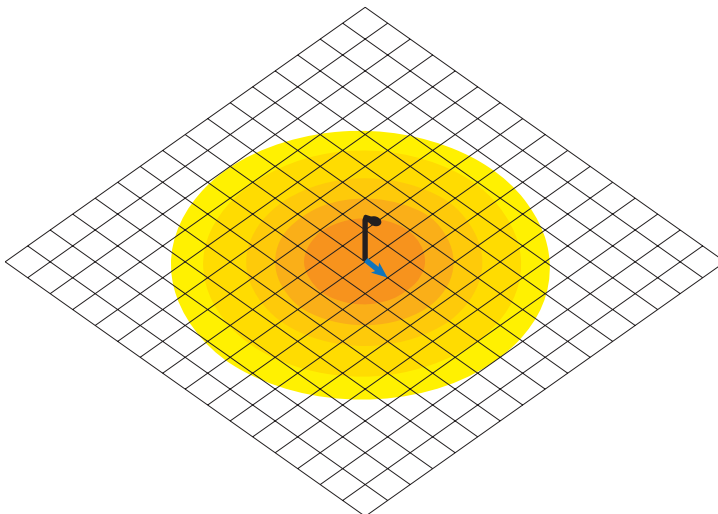

Structure-mount view from above; Area light mounted at 20'

