

TRK-LED-2X4-30-8XX

2X4 LED DOORFRAME RETROFIT KITS

PROJECT	
TYPE	
CATALOG #	



30W, 120-277V Input, 0-10V Dimming

DESCRIPTION: Upgrade existing fluorescent recessed troffer fixtures without modifying the existing fixture mounting

PRODUCT FEATURES

- Powered by 0-10V dimming LED drivers
- THD: <20%; power factor: > 0.90
- L70 > 50,000 hour lifetime
- Frosted lens eliminates glare
- 0-10V dimming, 10% minimum
- Ambient operating temperature: -20°C/-4°F to 50°C/122°F
- Compatible with emergency LED drivers
- Eligible for DLC multiple listing

Catalog Number	Input Voltage	Wattage	Color Temperature	Lumen Output	CRI	Power Factor	Efficacy	Lifetime
TRK-LED-2X4-30-835	120-277V	30W	3500K	3,750	>80	>0.9	125 lm/W	50,000 Hours
TRK-LED-2X4-30-840	120-277V	30W	4000K	3,800	>80	>0.9	127 lm/W	50,000 Hours
TRK-LED-2X4-30-850	120-277V	30W	5000K	3,910	>80	>0.9	130 lm/W	50,000 Hours

PROJECT	
TYPE	
CATALOG #	

PHYSICAL SPECIFICATIONS

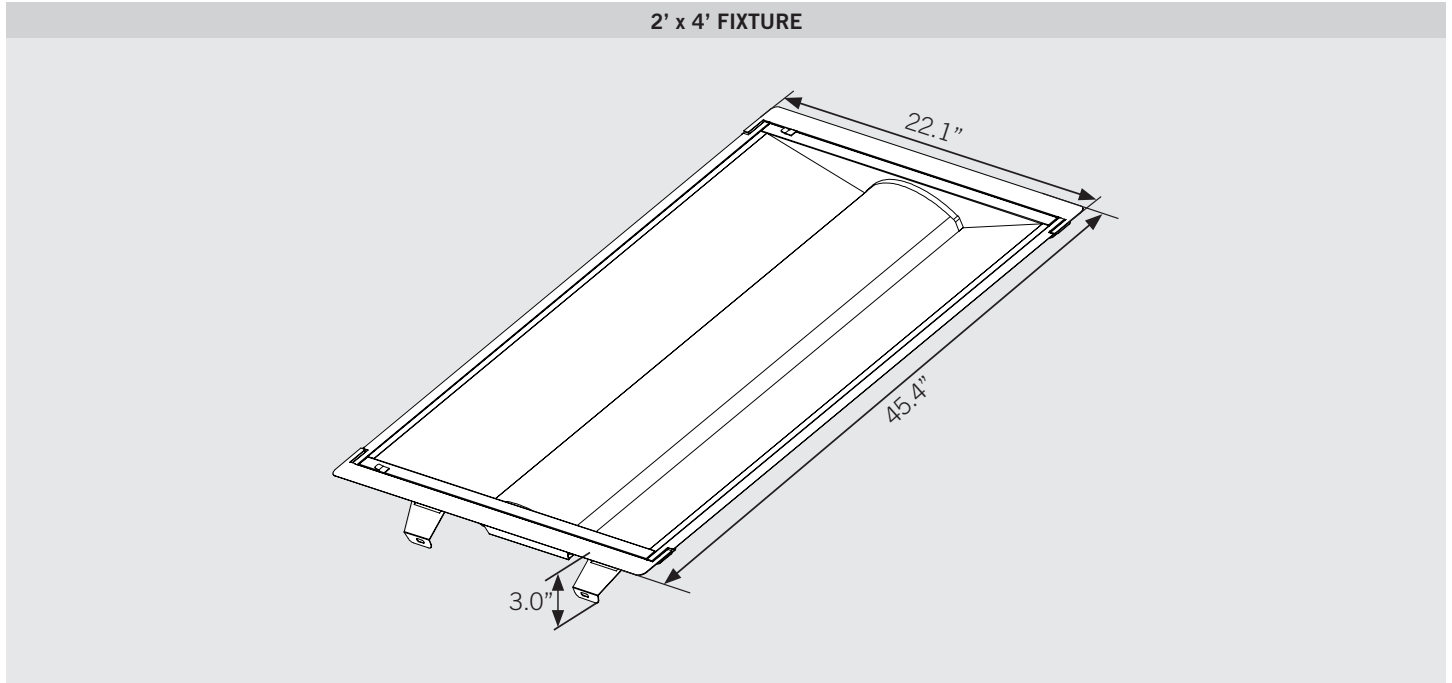

COMPONENT SUMMARY

Part	Qty.
End Plates	2
Side Plates	2
Door Assembly Body	1
Self-Tapping Screws	4